

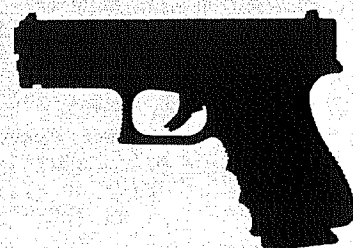

PERFECTION

# GLOCK 19

AIRSOFT GUN | cal. 6 mm



Operating instructions • Bedienungsanleitung • Manual de instrucciones

## GLOCK 19

AIRSOFT GUN | cal. 6 mm



Officially Licensed Product of GLOCK.  
Not intended for sale in France, including  
French-administered territories outside of  
Europe and French overseas territories.



**⚠ WARNING** Read the enclosed operating instructions carefully before loading or using the GLOCK Airsoft Gun.

**⚠ WARNING** The GLOCK Airsoft Gun is not a toy. Abuse or careless handling may cause injuries. Eye protection required.



**⚠ WARNING** You should be fully familiar with the proper and safe handling of your airsoft gun. The basic principles of airsoft gun safety require you to always apply the following rules when handling the airsoft gun.

- Always treat an airsoft gun as if it was loaded.
- Keep your finger away from the trigger. It should be straight and should rest on the trigger guard.
- Only use the kind of projectiles suitable for your airsoft gun.
- Always keep the muzzle pointed in a safe direction.
- This airsoft gun may only be discharged in your own house, on authorized shooting ranges and inside enclosed private property. It is to be made sure that no projectile can leave the enclosed property.
- Keep the danger area (250 m) of the projectile in mind.
- Never transport a loaded airsoft gun. Only load your airsoft gun when you intend to fire it.
- Never aim your airsoft gun at persons or animals. Avoid ricochets. Never fire at smooth, hard surfaces or water.
- Before you discharge your airsoft gun, make sure that target and surrounding area are safe.
- Always make sure that the airsoft gun is not loaded when you transport it or take it from another person.
- Make sure that you always have full control over the muzzle of your airsoft gun, even if you stumble or fall down.
- Safety shooting glasses should always be worn when firing the airsoft gun.
- Always store your airsoft gun in a safe place and in unloaded condition. Unauthorized persons (persons not familiar with the use of airsoft guns, children) must not have access to it. Ammunition is to be kept in a separate place.
- This airsoft gun and its operating instructions may only be passed on to persons
  - who are fully familiar with its use and
  - who have reached the legally stipulated minimum age in the respective country.
- Modifications or repairs of airsoft guns are only to be effected by authorized agencies or by a skilled gunsmith.
- Never leave a loaded airsoft gun unattended.
- Only unloaded airsoft guns are to be handed over to another person.
- This airsoft gun is not intended for hunting.

## REPAIR

An airsoft gun that does not work properly is dangerous. Do not attempt to repair this airsoft gun if it needs service. Incorrect assembly could lead to dangerous malfunctions.

**Caution: Repairs should only be completed by Umarex authorized centres.**



## SAFETY INSTRUCTIONS | WARRANTY

EN

**⚠ WARNING** Do not brandish or display this airsoft gun in public – it may confuse people and may be a crime. Police and others may think this airsoft gun is a firearm. Do not change the coloration and markings to make it look more like a firearm. That is dangerous and may be a crime.

**⚠ CAUTION** For your own safety and the safety of others, carefully read these instructions before using this airsoft gun. Buyers and owners must observe all rules concerning the use and ownership of this airsoft gun. Modifying this airsoft gun may result in a change of its classification under gun laws and is therefore prohibited. In such cases the manufacturer's warranty will immediately become void.

### WARRANTY

During the legal warranty period, which begins on the date of purchase, Umarex will repair or replace your airsoft gun at no charge provided the defect was not caused by you. Return your airsoft gun to an authorized dealer along with a description of the problem and proof of purchase.

The airsoft guns manufactured by UMAREX GmbH & Co. KG are made according to the regulations of the PTB (Physikalisch-Technische Bundesanstalt), German Federal Law, the CIP regulations and the technical know-how of UMAREX GmbH & Co. KG.

We will not assume any liability whatsoever if this product is exported to territories outside of Germany and as a consequence does not comply with domestic legal requirements of these territories. It will be the sole responsibility of the importer to ensure compliance with local laws and regulations.

### TECHNICAL DATA

Item no.	2.6418
System / Power Source	CO <sub>2</sub> Airsoft / 12 g CO <sub>2</sub> capsule
Caliber / Ammo	6 mm BBs
Capacity	11 rounds (BBs)
Energy	2 J
Velocity	up to 140 m/s
Sights	Fixed front and rear
Trigger	Double Action only
Safety	Trigger Safety
Dangerous area up to	250 m
Weight	717 g
Length	186 mm
Barrel length	108 mm
Color	black



# DESCRIPTION

EN





## SAFETY

EN

### ⚠ WARNING

• Always make sure that the muzzle points in a safe direction.

### ⚠ NOTICE

• This airsoft gun has an automatic trigger safety.



## PROBLEM SOLUTIONS

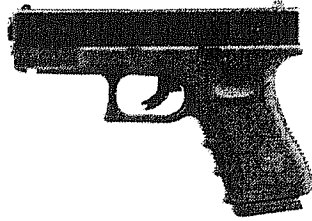

### POSSIBLE CAUSES

### PROBLEMS

	CO <sub>2</sub> capsule not inserted	Gas / CO <sub>2</sub> capsule / Magazine empty	Dirty barrel	Extreme temperatures	Wrong ammunition	Ammunition badly loaded
Faulty shooting direction		<input type="radio"/>	<input type="radio"/>	<input type="radio"/>	<input type="radio"/>	<input type="radio"/>
Airsoft gun does not shoot	<input type="radio"/>	<input type="radio"/>			<input type="radio"/>	<input type="radio"/>
Low shooting speed		<input type="radio"/>	<input type="radio"/>	<input type="radio"/>	<input type="radio"/>	<input type="radio"/>



## CHARGING OF GAS

EN

**CAUTION** • Only use 12 g CO<sub>2</sub> capsules. • For storage remove gas capsules.  
• There may be a minor discharge of gas when you remove the gas capsules.  
Make sure that your hands do not come into contact with discharged CO<sub>2</sub> gas. This may cause freezing of the skin. Do not expose the CO<sub>2</sub> cartridge to excessive heat and do not store it at temperatures exceeding 54°C. Always adhere to the warnings and safety instructions of the manufacturer on the gas cartridge in respect to handling and storage of a CO<sub>2</sub> gas container.

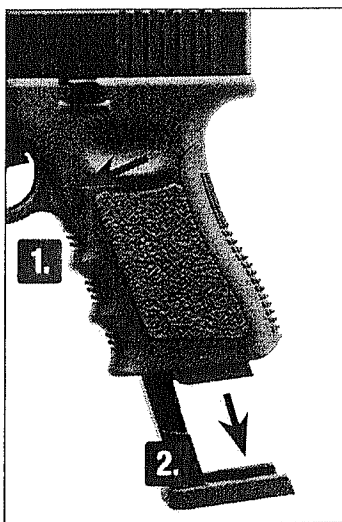

1. Press the magazine catch.  
2. Remove the magazine.

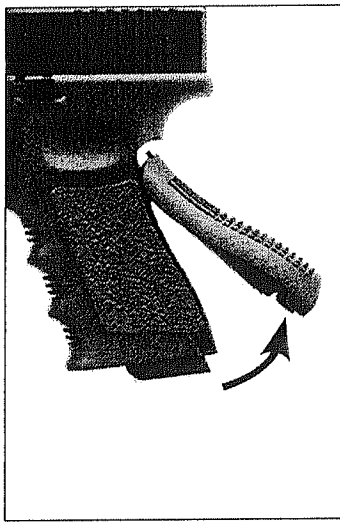

3. Remove the backstrap. This frees the loading port for the CO<sub>2</sub> cartridge.

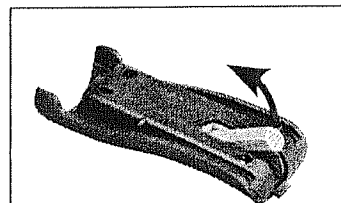

4. 5. Open piercing screw using Hex key in the backstrap.

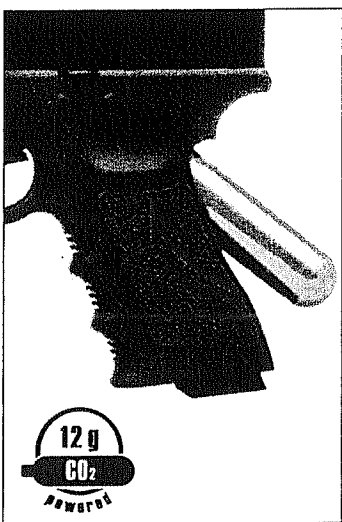
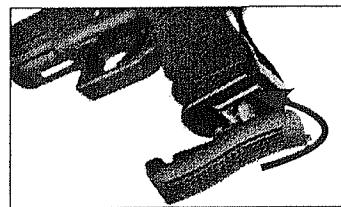

6. Insert CO<sub>2</sub> capsule as shown.

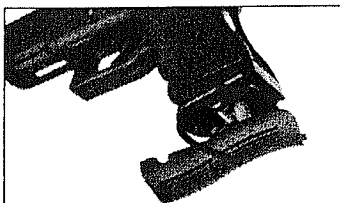

7. Turn piercing screw upwards, pierce capsule.

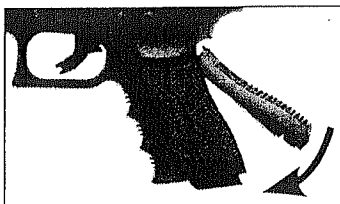

8. Reattach the backstrap.

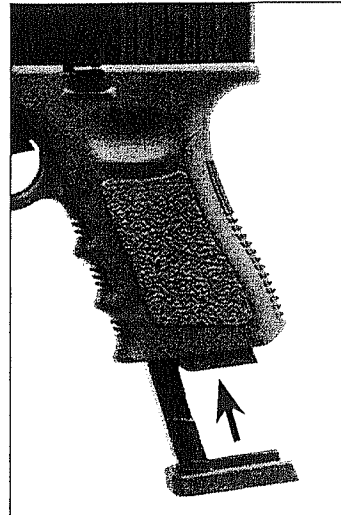

9. Insert magazine.



## LOADING THE MAGAZINE

EN

**NOTICE** • Only use flawless 6mm BBs. Other than flawless BBs may be capable of damaging your airsoft gun. Never use the following BBs:

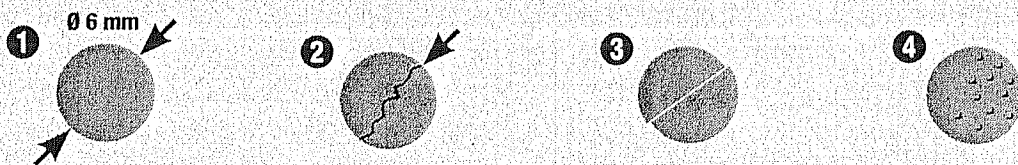

❶ diameter larger than 6mm, ❷ with edges, ❸ both halves not aligned, ❹ used, soiled. Warranty expires if non-recommended BBs are used. It's recommended to use precision BBs from Umarex/Walther. To ensure proper operation of the magazine, protect it from dirt and dust.

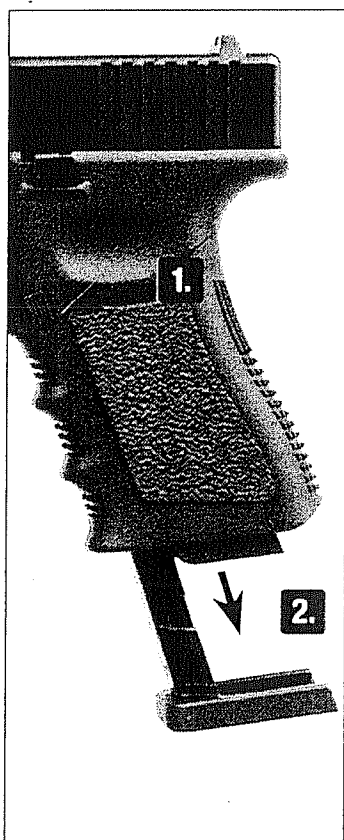

- 1 Press the magazine catch.
- 2 Remove the magazine.

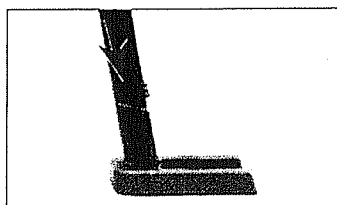

- 3 Pull down and lock magazine follower.

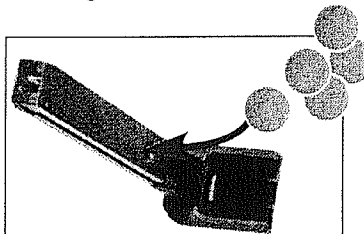

- 4 Load BBs.

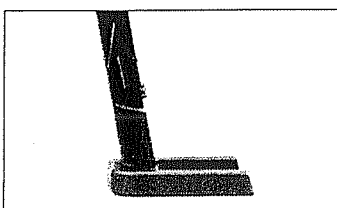

- 5 Release Follower.

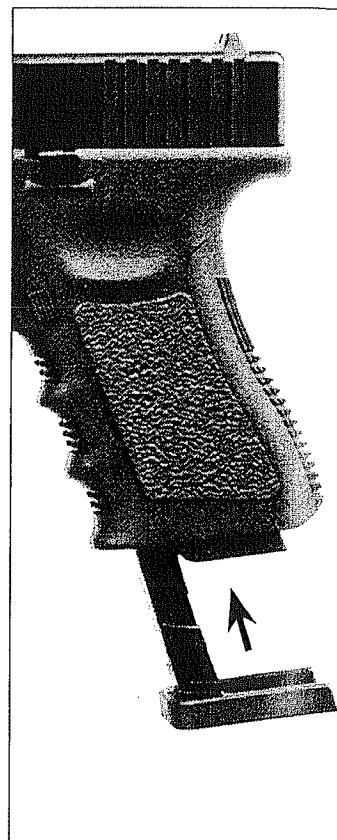

- 6 Insert magazine.



## SIGHTS

EN

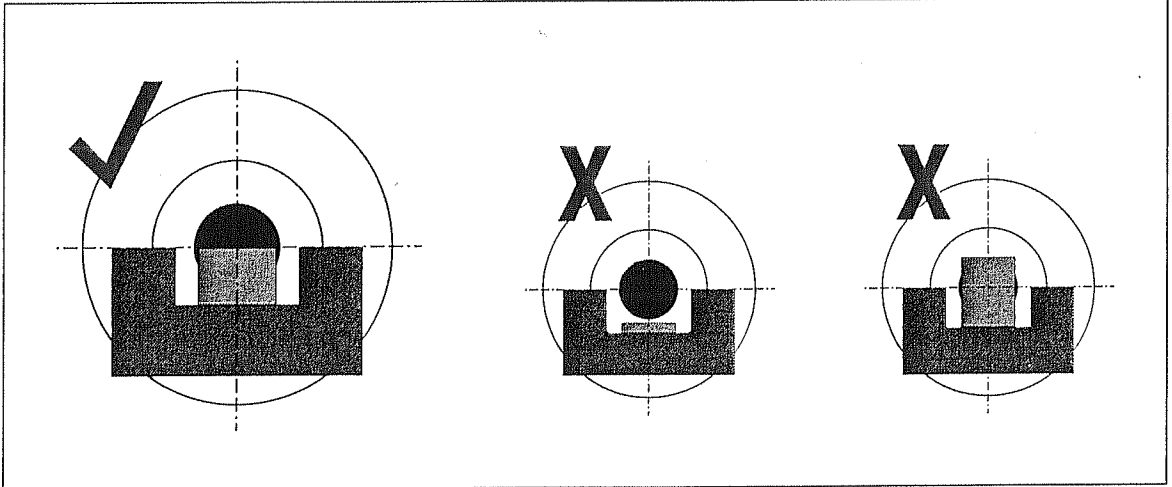

## SHOOTING

**⚠ WARNING** • You and others with you must wear shooting glasses to protect your eyes. If you need optical or reading glasses, you must wear safety glasses intended for use with optical or reading glasses.







## BARREL CLEANING

EN

**⚠ WARNING** • Unload your airsoft gun before cleaning it: Press the magazine catch and remove the magazine. Make sure there is no BB left in the chamber.

**⚠ NOTICE** • Do not force the rod into the barrel, as this could cause damage.  
• Never drip silicone oil directly into the barrel.

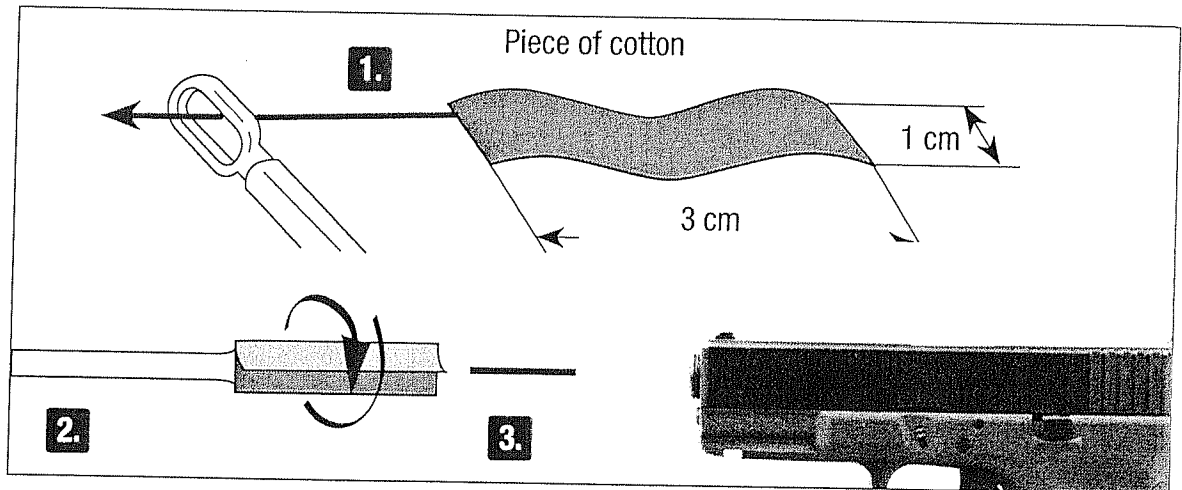

Prepare a thin rod with a length of approx. 30 cm. Attach a piece of cotton fabric to its end and clean the barrel with some silicone oil.

Occasionally clean the metal parts on the outside. Use a cloth which has been slightly dampened with some gun oil.

## MAINTENANCE (FOR CO<sub>2</sub> AIRSOFT GUN ONLY)

Clean your airgun at regular intervals (250 shots) using a maintenance capsule. We recommend the use of the Walther maintenance capsule 4,1683.

### How to use the maintenance capsule:

Remove all BBs from the airsoft gun, insert the maintenance capsule and pierce it. Turn the airsoft gun upside-down so that the trigger is on top. Then point the airsoft gun in a safe direction and fire until the capsule is empty.

